

水管理・国土保全局配置図

総務課、水政課、河川計画課、河川環境課、治水課

中央合同庁舎3号館 1F R5.22現在

■109

■110

■112

■114

■106

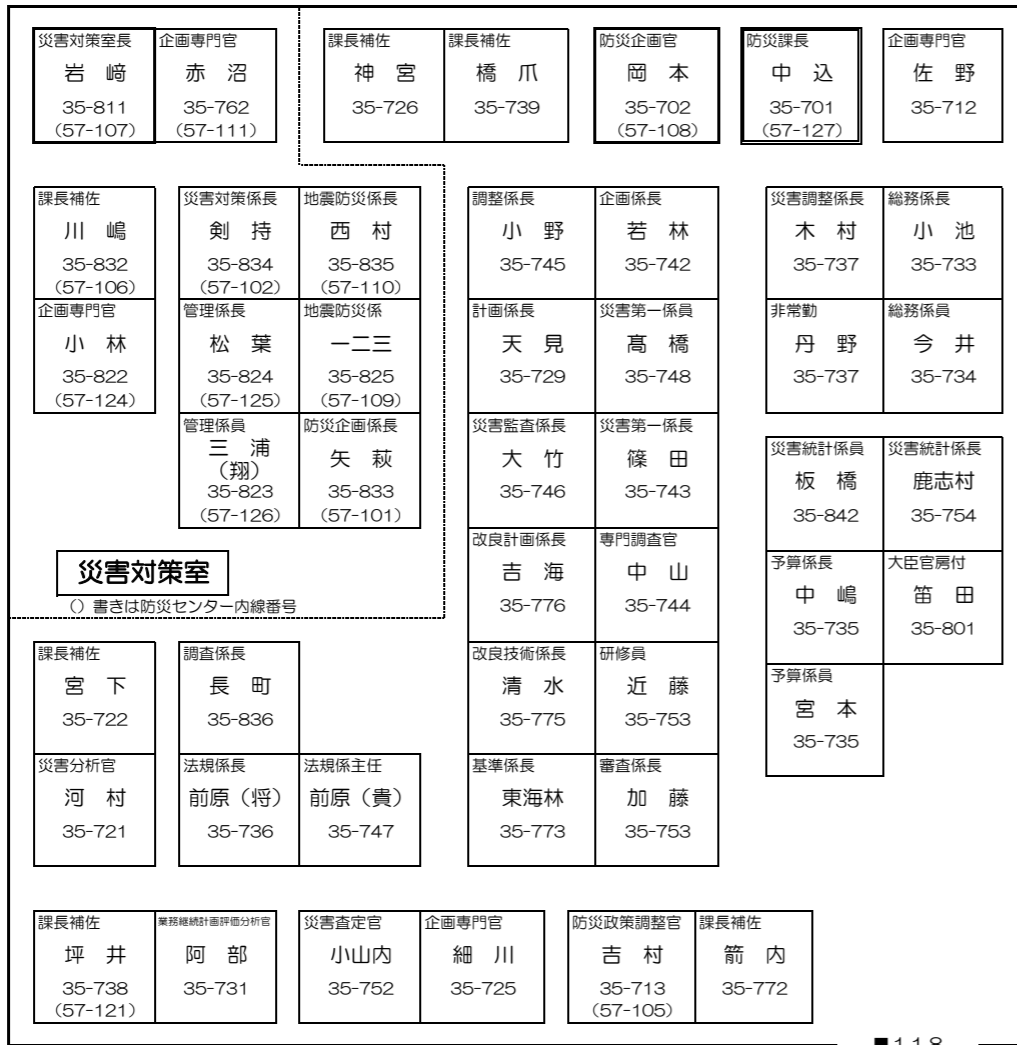

■ 118

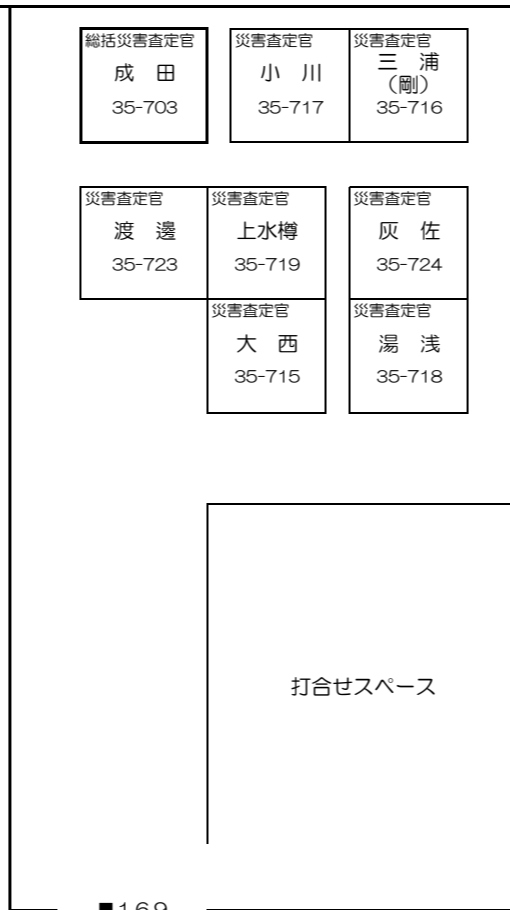

■ 169

防災課 (1F)

○ 書きは防災センター内線番号

水管理・国土保全局

防災課、砂防部

中央合同庁舎3号館

1F/2F R5.5.22 現在

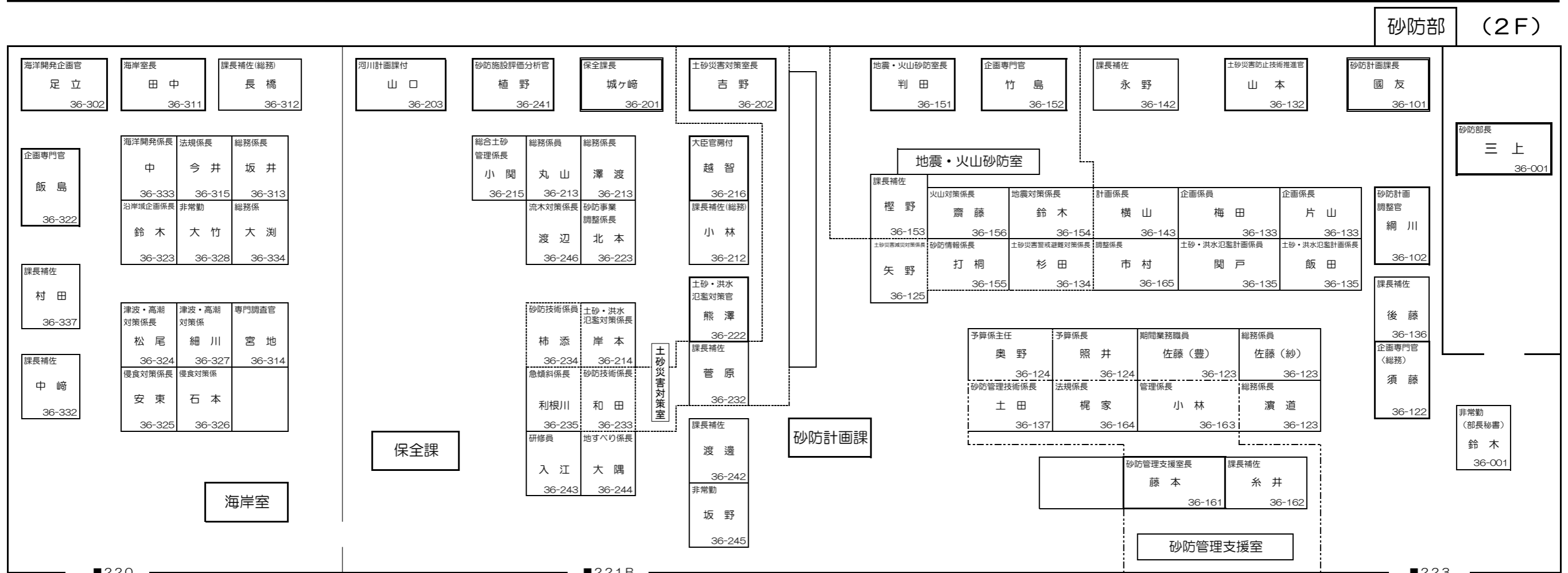

■ 220

■ 221B

■ 223

水資源部

下水道事業課

下水道企画課

下水道部長

水資源計画課

水資源政策課

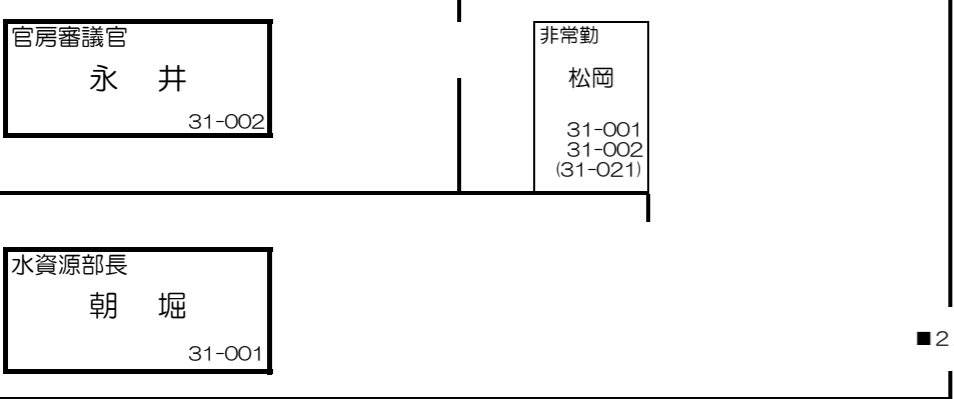
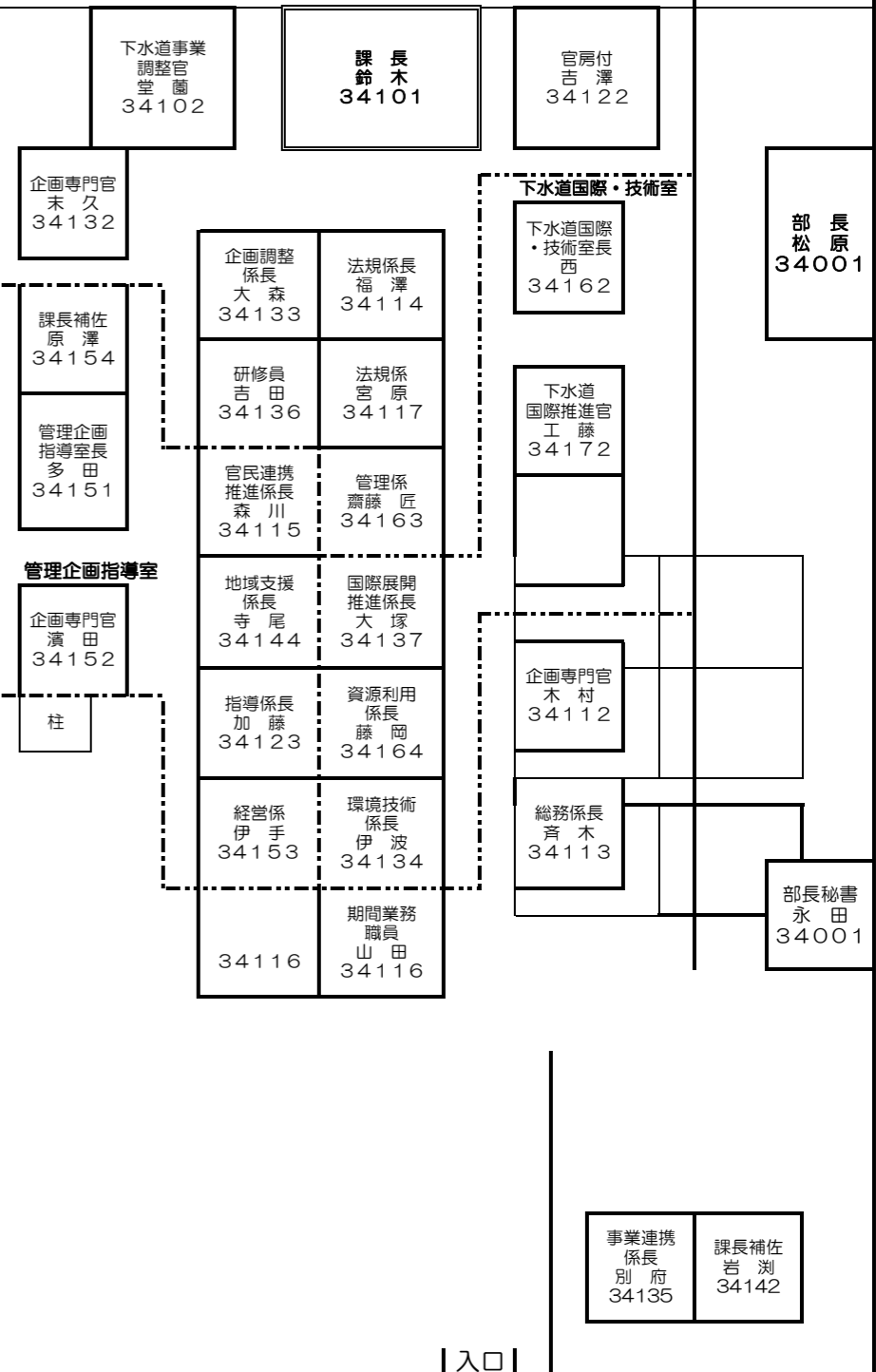
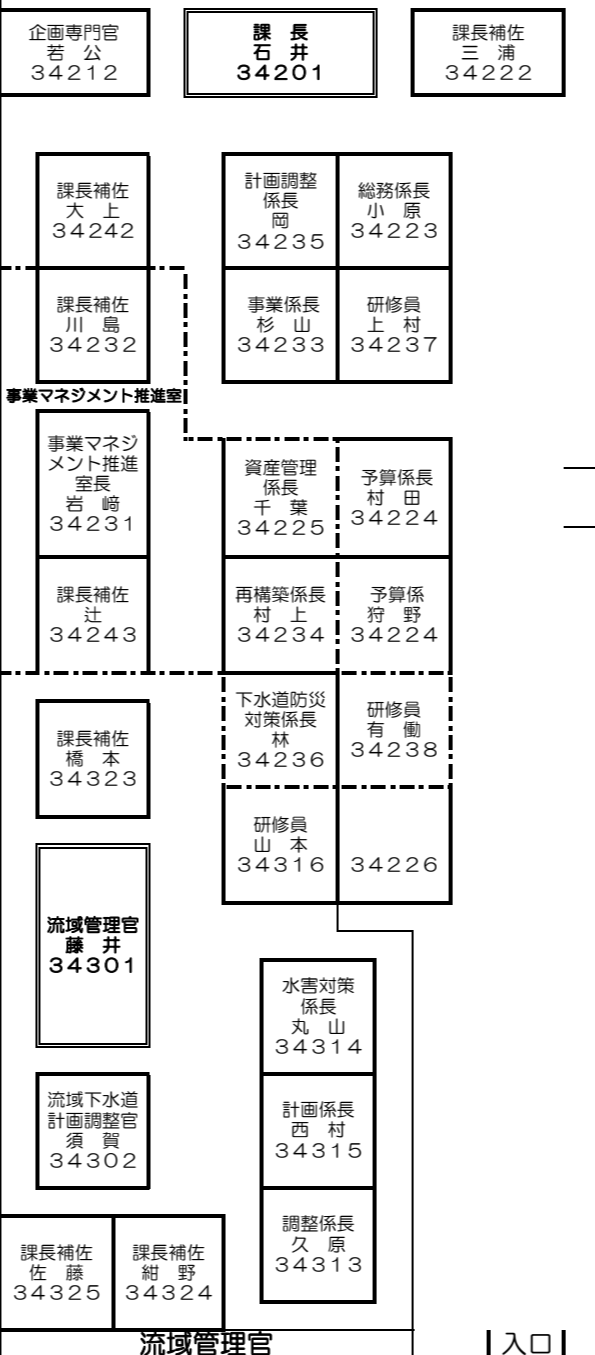
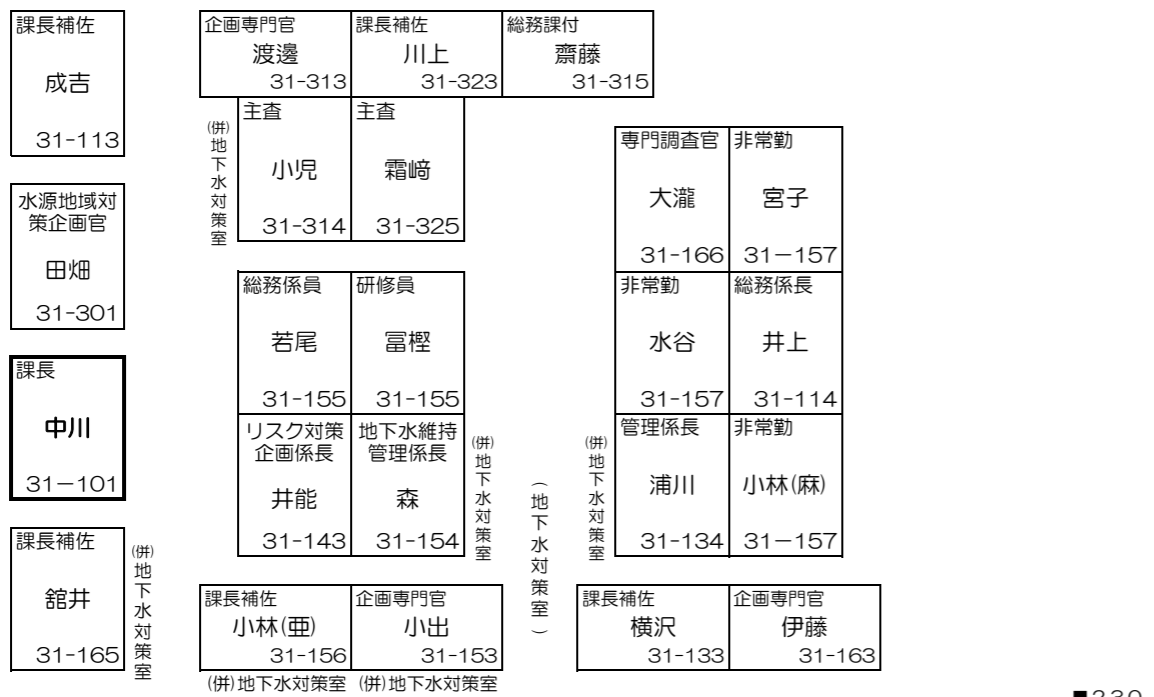
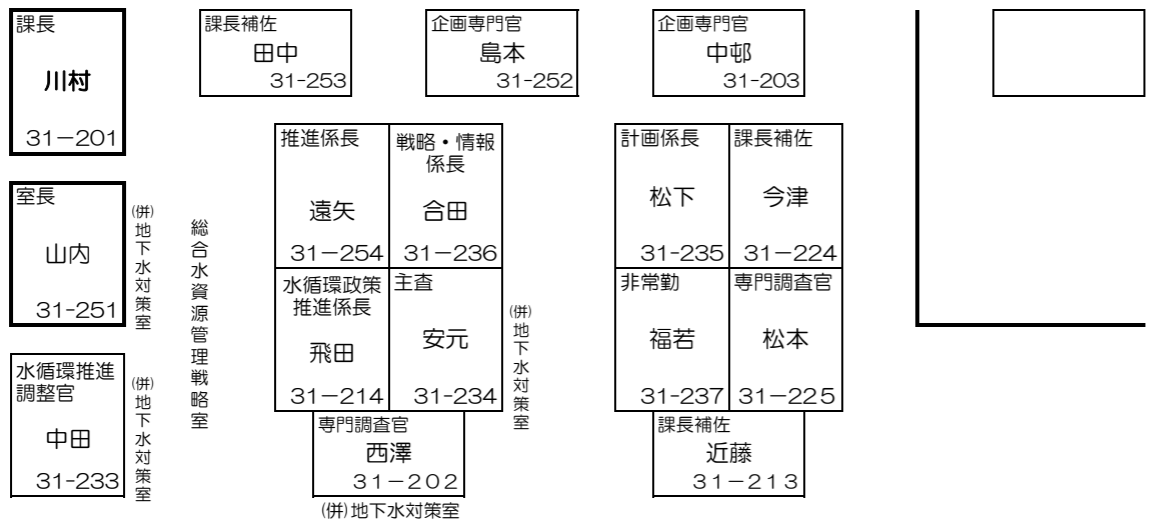

水管理・国土保全局
 水資源部、下水道部
 中央合同庁舎3号館 2F
 R5.5.22 現在