

水管理・国土保全局

防災課、砂防部

中央合同庁舎3号館

1F/2F R5.7.11 現在

防災課 (1F)

() 書きは防災センター内線番号

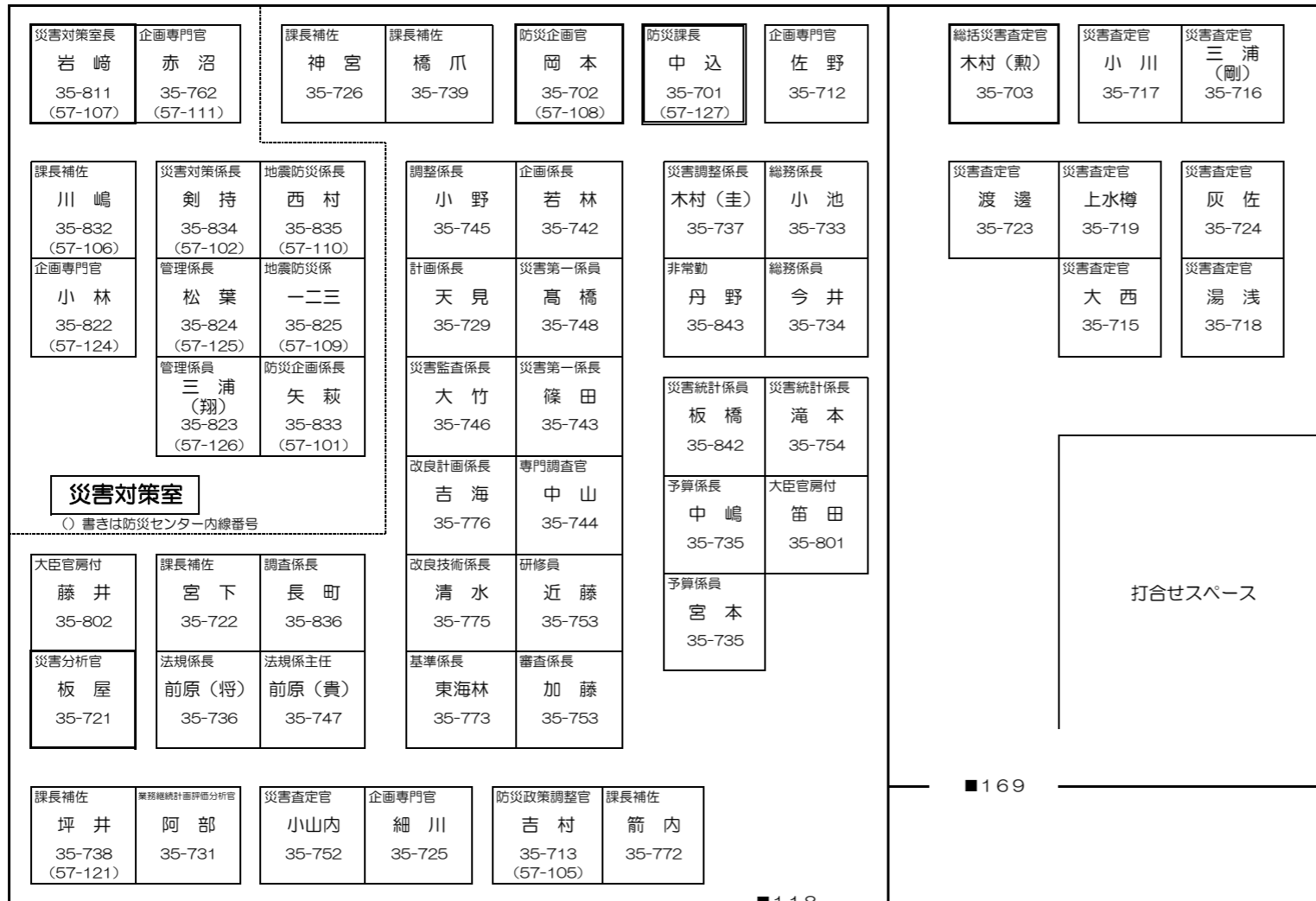

■169

■118

砂防部 (2F)

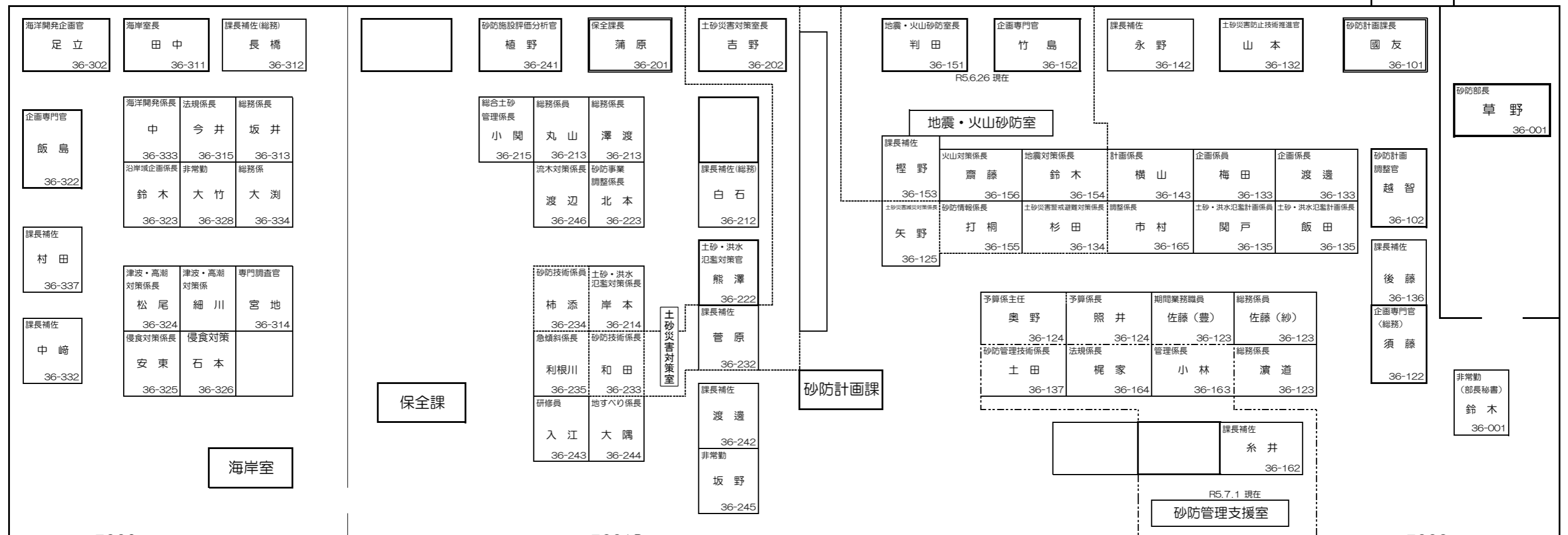

■220

■221B

■223

水資源部

下水道事業課

下水道企画課

下水道部長

水資源計画課

水資源政策課

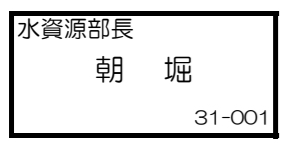
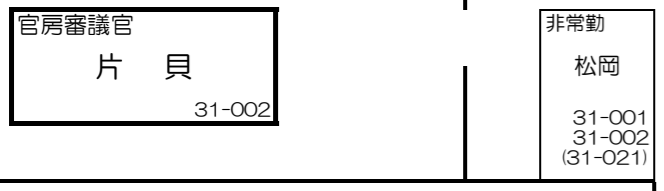
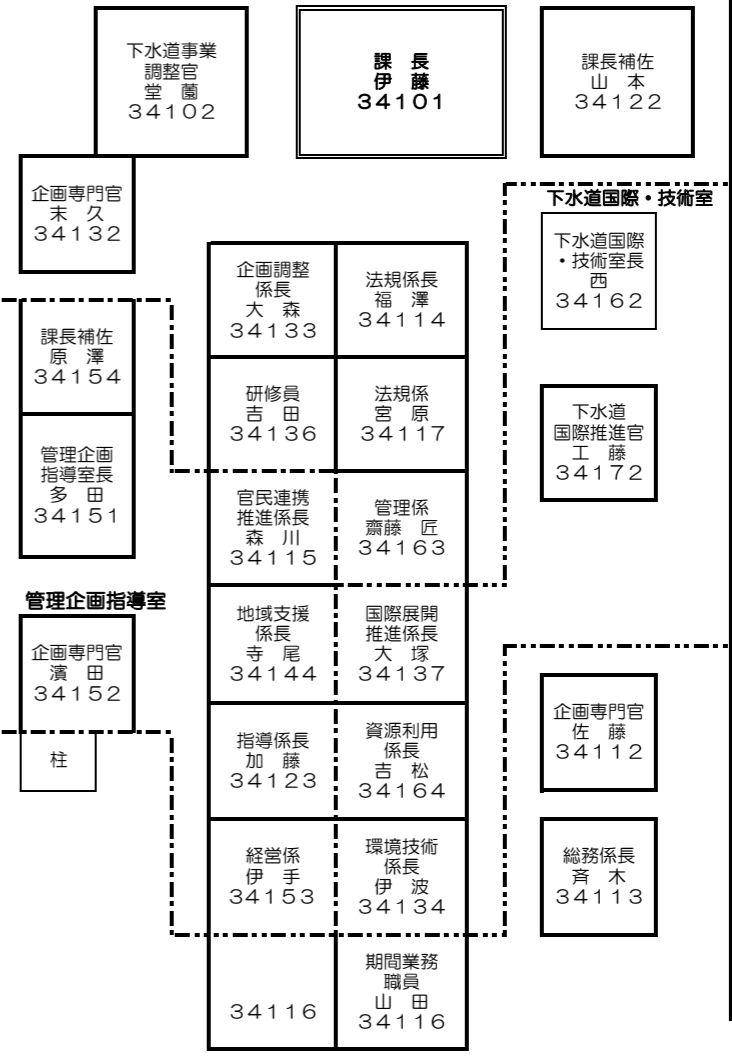
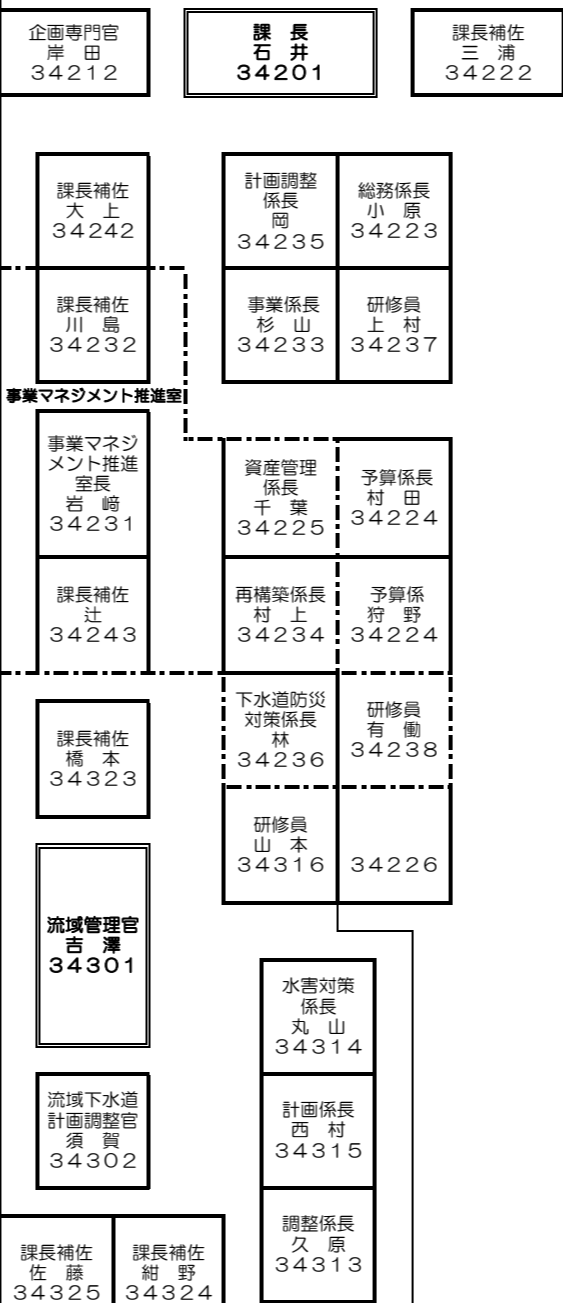
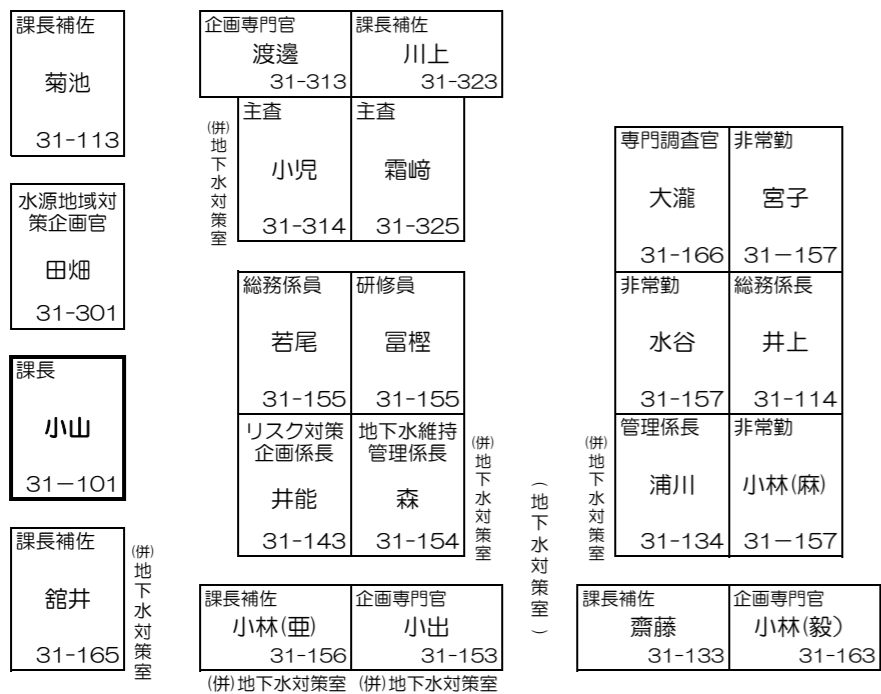
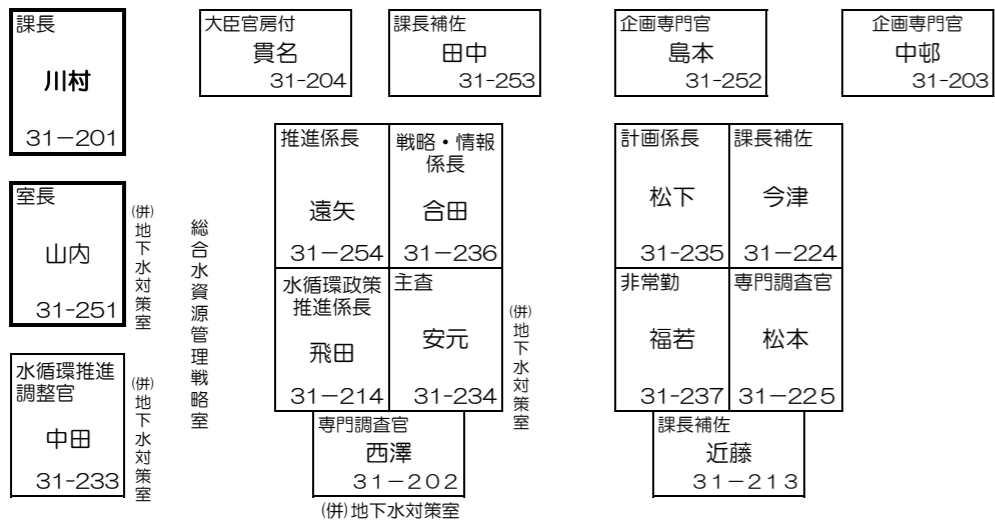

水管理・国土保全局
水資源部、下水道部
中央合同庁舎3号館 2F
R5.7.11 現在